

Single-Mode Digital Tethered Head H-Type Module



Innovative Photonic Solutions' Tethered Head H-type module is a fully turn-key, UL/CE and IEC certified laser diode module perfect for lab use. It comes with an internal wavelength stabilized laser module, a laser enable switch for safety, an LED readout, an output power control dial, a safety key lockout, a remote interlock, and an emergency shut-off switch (EMO). The digital 'Tethered Head' module offers USB connectivity, ease of use and flexibility for different setups, and allows the user to bring the open beam laser output to the sample. IPS' proprietary Wavelength Stabilized Laser features high output power with narrow spectral bandwidth. The laser's stabilized peak wavelength remains "locked" regardless of case temp (10 to +45 °C). Devices can be spectrally tailored to suit application needs and offer side mode suppression ratio (SMSR) better than 45 dB

Standard Wavelengths

All specified wavelengths are measured "in-vacuum"

Applications

This laser package is designed for turn-key operation and is ideal for:

- High Resolution Raman Spectroscopy
 - Portable Raman
 - Process Raman
 - Confocal Microscopy
 - Raman Imaging
- Metrology/Interferometry
- Remote Sensing

Key Features

- Wavelength Stabilized Spectrum
- Narrow Spectral Linewidth (<1 MHz FWHM)
- High Power Single-Mode Open Beam Output
- TEM00, Single-Spatial and Single-Longitudinal Mode (SLM)
- Circularized & Collimated Output Beam
- >50 dB SMSR Typical
- USB Interconnectivity
- UL/CE and IEC Certified & Fully turn-key
- Integral Laser Line Filters at 633nm, 638nm, 785nm, 808nm, and 830nm
- External fiber patch cord sold separately

633nm	685nm	785nm	852nm
638nm	780nm	808nm	976nm
660nm	783nm	830nm	1053nm
			1064nm

Specifications



Wavelength Tolerance	+/- 0.5nm
Spectral Linewidth	<1 MHz
Operating Temperature Range	10 - 45 °C
SMSR (no laser line filter)	45 - 50 dB typical
SMSR (w/laser line filter)	>70 dB typical
Polarization Orientation	Perpendicular to the plane of baseplate mounting plane
Polarization Extinction Ratio (PER)	>17 dB (typical)
Beam Quality (M^2 , $1/e^2$)	<1.5 (1.3 Typical)
Spot Size ¹	~1.5mm with beam expander
Divergence ²	< 1 mrad typ. with beam expander
Output Power Stability	<0.5% RMS
Modulation Rate	CW to kHz at 50% duty cycle or CW to 1kHz at 10-100% duty cycle
Warm-Up Time	10 sec from cold start to <1 wavenumber
	1.5 sec from warm start to <1 wavenumber
	3 sec from warm start to <0.1 wavenumber

λ (nm)	Output Power (mW)	Base Part Number
633	50	I0633SH0050BX-TH-L-USB
638	50	I0638SH0050BX-TH-L-USB
660	60	I0660SH0060BX-TH-L-USB
685	40	I0685SH0040BX-TH-L-USB
780	100	I0780SH0100B-TH-L-USB
783	100	I0783SH0100BX-TH-L-USB
785	100	I0785SH0100BX-TH-L-USB
	150	I0785SH0150BX-TH-L-USB
808	100	I0808SH0100BX-TH-L-USB
	150	I0808SH0150BX-TH-L-USB
830	100	I0830SH0100BX-TH-L-USB
	150	I0830SH0150BX-TH-L-USB
852	150	I0852SH0150BX-TH-L-USB
976	150	I0976SH0150BX-TH-L-USB
1053	150	I1053SH0150BX-TH-L-USB
1064	150	I1064SH0150BX-TH-L-USB

1. H-type optical head comes standard with beam expander, add - NBE to part number for no beam expander. Spot size measured at 500 mm.
2. For 785nm, beam divergence is ~ 3 - 4 mrad without beam expander

Part Schema

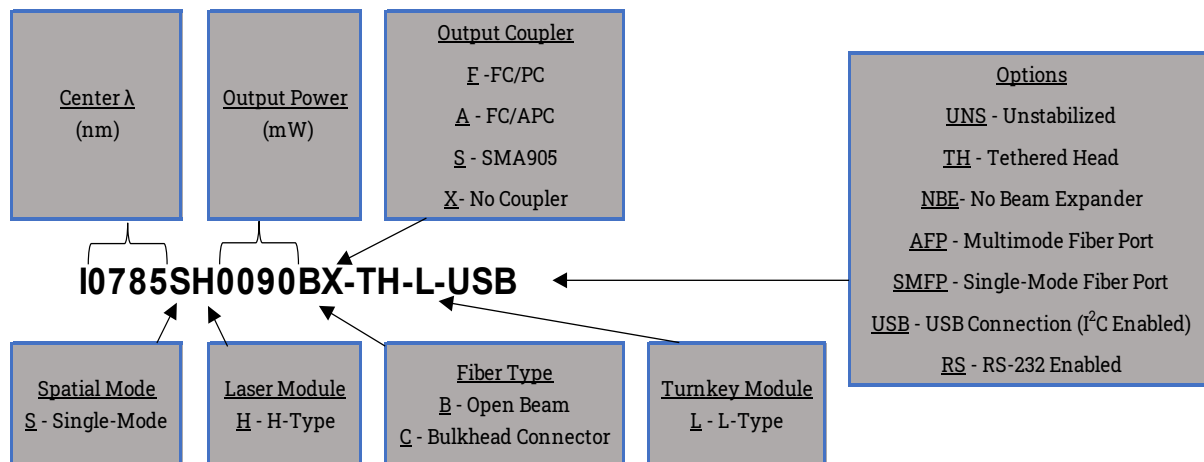

Selected Data

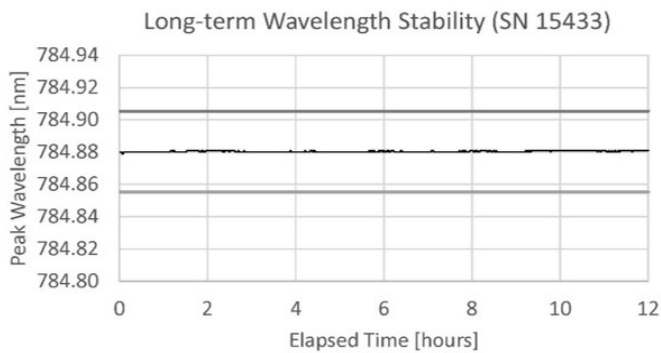
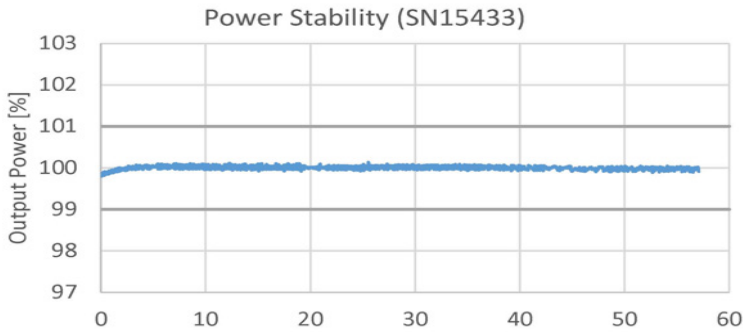

Module Dimensions	9.48" x 6.94" x 4.14" 48oz
H-Type Head Dimensions	3.82" x 1.2" x 1" 10oz
Case Material	Anodized Aluminum
Operating Temperature	10 to 45 °C
Environment	0-80% Humidity, Non-Condensing
Storage Temperature	-10 to +55 °C

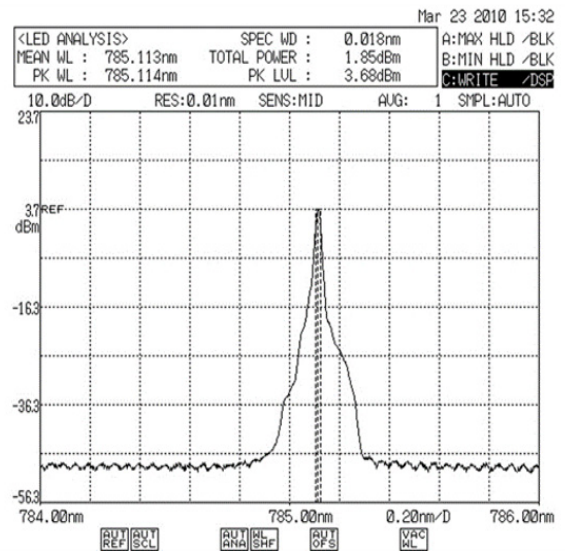

Custom Capability

- Custom wavelengths available upon request
- Adjustable beam expander to set beam diameter at specified distances
- Optical isolator available for 633nm, 638nm, 780nm, 785nm in standard H-Type module
- Optical isolator available for 976nm and 1064nm in larger H-Type module
- IPS' turn-key system comes standard with a US outlet plug. Europe, UK, and Australia outlet plugs are available as accessories upon request

Electrical Specs

Input Power	100 - 240 VAC 50 - 60Hz, 0.4A
Fuse Rating	250V, 1A, FastBlow 5mm x 20mm, 2 each

Mechanical Drawings

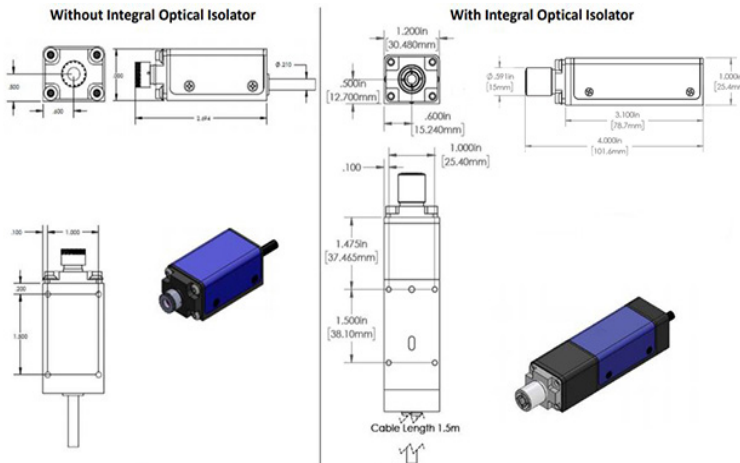

NOTE: H-Type Tethered Head comes standard with beam expander for spot size ~ 1.5 mm and divergence < 1 mrad

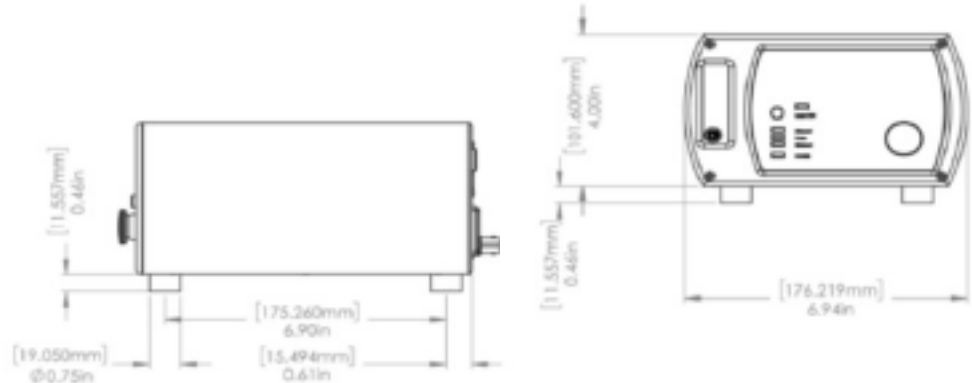
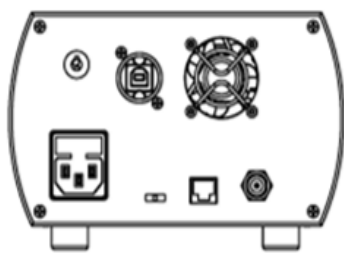
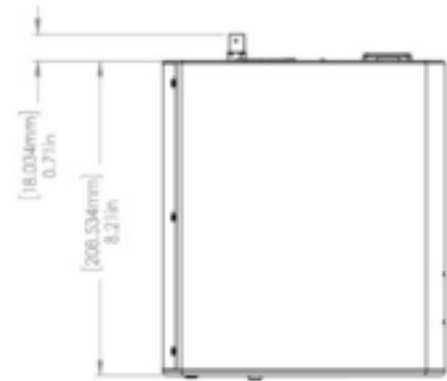

Operational Notes

1. Do not retro-reflect beam! This can cause Catastrophic Optical Damage (COD) and is not covered under warranty (unless optical isolator is included).
2. A VBG-locked Single-mode laser will experience mode hops as the temperature and driver current are changed (see [Mode-Hop White Paper](#)). For this reason, IPS profiles and sets both the current and temperature for this module and does not allow user adjustment.
3. Digital Tethered Head modules offer the ability to adjust laser output power by connecting to a computer and adjusting the laser's operational duty cycle. Alternately, users can connect to the BNC port on the back panel and inserting their own Pulse Width Modulated (PWM) duty cycle. By using PWM, user can adjust average power from 10% to 100%. For example, if a 50% duty cycle is selected, the laser will be on 50% of the time, and off 50% of the time, making the average power equal to 50% of the CW output power. The sample will experience a lower average power (equal to % duty cycle). Rise/fall time is approximately 5 microseconds.
4. See the [user guide](#) for full operating and safety instructions. This document is meant to offer a product overview.

Innovative Photonic Solutions, Inc.

313 Enterprise Drive
Plainsboro, NJ 08536

Phone: (732) 230-1601

sales@ipslasers.com
www.ipslasers.com



All data and statements contained herein are subject to change in accordance with Innovative Photonic Solution's policy of continual product improvement. No information contained herein is intended for use in connection with any contract except as may be first confirmed in writing by Innovative Photonic Solutions. The publication of information in this document does not imply freedom from patent or other rights of Innovative Photonic Solutions or others. OEM Laser Product