

Single-Mode Open Beam Butterfly Package

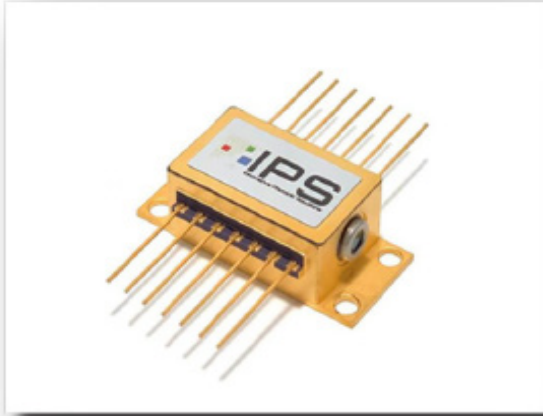

Innovative Photonic Solutions' proprietary Single-Mode Wavelength-Stabilized laser diode features high output power with ultra-narrow spectral bandwidth and a diffraction limited output beam. Designed to replace expensive DFB, DBR, fiber, and external cavity lasers, the single-mode spectrum stabilized laser offers superior wavelength stability over time, temperature, and vibration, and is manufactured to meet the most demanding wavelength requirements. The single-mode packaged product line comes standard with a circularized output beam, internal photodiode, thermistor and ESD protection. Lasing wavelength can be accurately specified and repeatedly manufactured to within +/-0.1 nm upon request.

Standard Wavelengths

All specified wavelengths are measured "in-vacuum"

Applications

This laser package is designed for OEM Integration and is ideal for:

- High Resolution Raman Spectroscopy
Confocal Microscopy
Raman Imaging
Portable Raman
Process Raman
- Direct-Diode Frequency Doubling
- Fiber Laser Seeding
- Metrology & Interferometry
- Remote Sensing

Key Features

- High-Power Single-Spatial-Mode, Single-Frequency Output
- Ultra-Narrow Spectral Linewidth (< 100 kHz)
- Stabilized Output Spectrum (< 0.007 nm/°C)
- Excellent Beam Quality ($M^2 < 1.2$)
- Integral ESD Protection & Thermistor
- Integral Laser Line Filter
- SMSR 70 dB w/ laser line filter (40 dB without)

633nm	780nm	830nm	1053nm
638nm	783nm	852nm	1064nm
660nm	785nm	976nm	
685nm	808nm	1030nm	

Specifications



Wavelength Tolerance	+/- 0.5 nm
Spectral Linewidth	~ 100kHz* instantaneous
Wavelength Stability Range	15 C - 45 °C
SMSR	35 - 45 dB
SMSR w/integral laser line filter	70 dB typical
Power Stability	1% typical
Polarization Extinction (PER)	>17dB, 20dB Typical
Spatial Profile	TEM00
Beam Exit Angle	< 3 degrees
Beam Quality (M^2 , $1/e^2$)	<1.2
Beam Ellipticity	< 1.5:1
Beam Divergence	~2 mrad

λ (nm)	Output Power (mW)	Base Part Number	Max Current, Voltage
633	50	I0633SB0050B	175mA, 3.3V
638	60	I0638SB0060B	250mA, 3.3V
660	60	I0660SB0060B	250mA, 3.3V
685	40	I0685SB0040B	60mA, 3.3V
780	100	I0780SB0100B	200mA, 2.5V
783	100	I0783SB0100B	200mA, 2.5V
785	100	I0785SB0100B	200mA, 2.5V
	175	I0785SB0175B	400mA, 2.5V
808	175	I0808SB0175B	400mA, 2.3V
830	175	I0830SB0175B	500mA, 2.3V
852	175	I0852SB0175B	500mA, 2.3V
976	500	I0976SB0500B	750mA, 2.2V
	700	I0976SB0700B	1000mA, 2.2V
1030	450	I1030SB0450B	750mA, 2.2V
1053	500	I1053SB0500B	750mA, 2.2V
1064	500	I1064SB0500B	750mA, 2.2V

*Requires driver electronics with very low noise analog laser driver along with a design for dual TECs for improved temperature control. Refer to the [Linewidth White Paper](#) on our website for further details

Part Schema

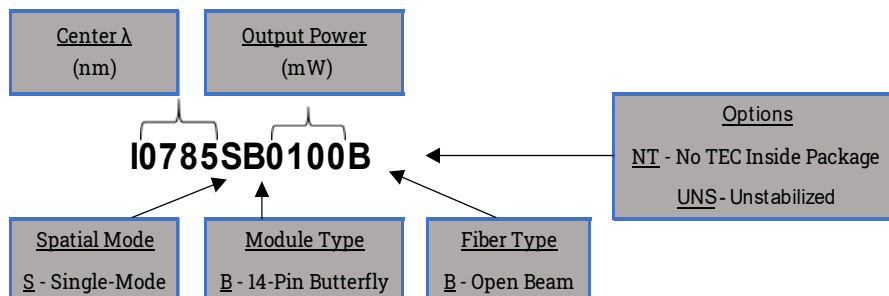

Selected Data



TEC Current Limit	3.2 A
TEC Voltage Limit	5.8 V
Photodiode Current	30 μ A
Integral Thermistor	Betatherm 10K3CG3

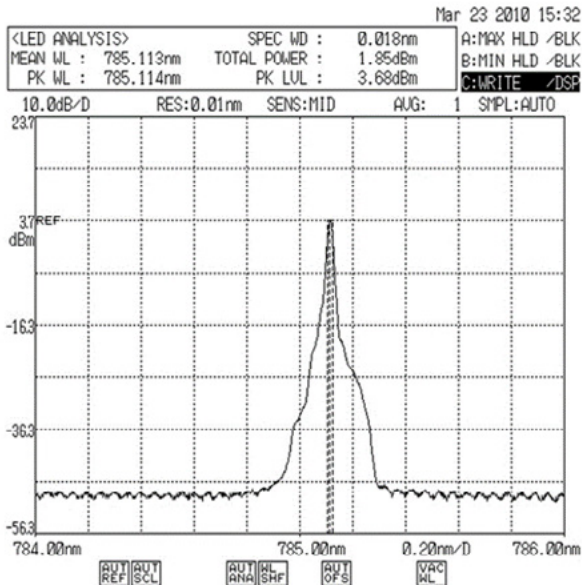

Typical 785nm SS Laser Spectrum

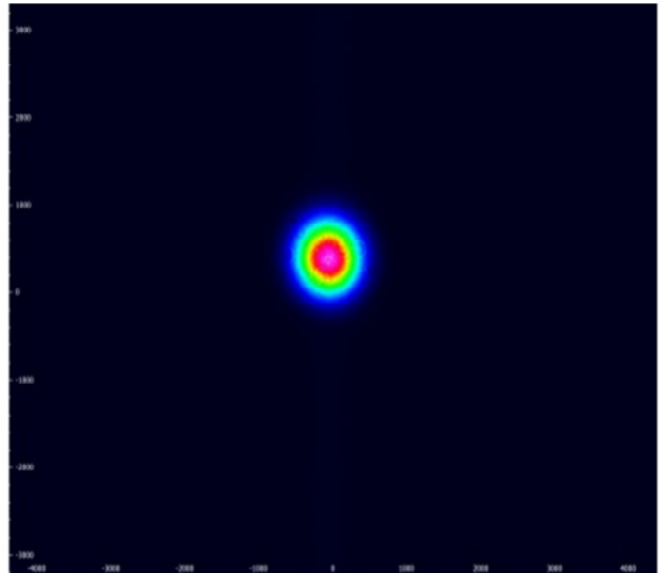

Typical 785nm Beam Quality

Custom Capability

- Custom wavelengths available upon request.
- External TEC (e.g. No TEC inside of package optional)

Electrical Specs

Pin 1	TEC+
Pin 2	Thermistor (10kOhm @25°C)
Pin 3	PD Anode
Pin 4	PD Cathode
Pin 5	Thermistor
Pin 6-8	NC
Pin 9	Laser Cathode (-)
Pin 10	Laser Anode (+)
Pin 11	Laser Cathode (-)
Pin 12	NC
Pin 13	Case Ground
Pin 14	TEC -

Mechanical Drawings

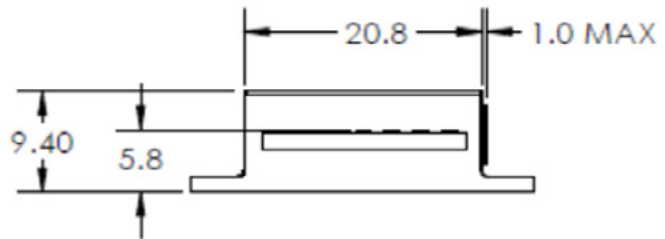
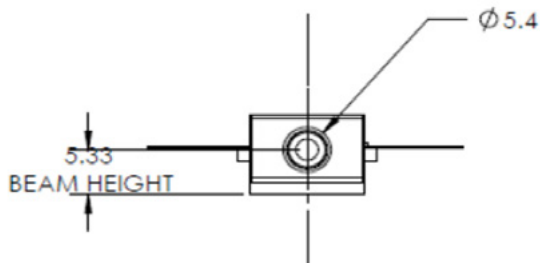
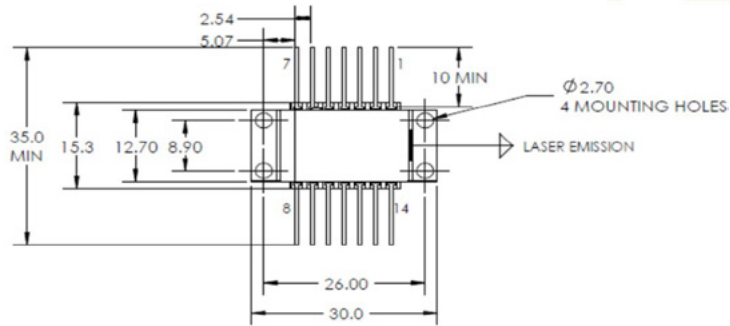

OEM Laser Product: This laser module is designed for use as a component (or replacement) part and is thereby exempt from 21 CFR1040.10 and 1040.11 provisions.

Operational Notes

1. 14-pin BF should be mounted on a heat sink with a thermal compound (thermal grease).
2. Take care not to over-tighten screws when mounting. This can bend the BF package causing damage and hindering performance and is not covered under warranty.
3. Laser and TEC driver circuitry should be configured in a manner to prevent power /current / voltage surges and spikes.
4. IPS recommends not grounding anode and cathode as this can cause ground loops.
5. Laser and TEC driver circuitry should be configured in a manner to prevent power /current / voltage surges and spikes.
6. Do not retro-reflect beam! This can cause Catastrophic Optical Damage (COD) and is not covered under warranty.
7. Laser will operate in single frequency mode at set-points between 10 and 45°C, however, optimal operating set point must be determined for each laser diode to avoid mode-hopping (see note 8).
8. To determine optimal operating point, plot wavelength vs temperature and wavelength vs. current to determine where mode-hop locations are. Set operating temperature and current halfway between mode-hops. This will ensure the most stable operation (See [Mode Hop Whitepaper](#) for more details).

Innovative Photonic Solutions, Inc.
313 Enterprise Drive
Plainsboro, NJ 08536

Phone: (732) 230-1601

sales@ipslasers.com
www.ipslasers.com

